

Step 12

Z1-1x4 Z5x4 S1-1X80

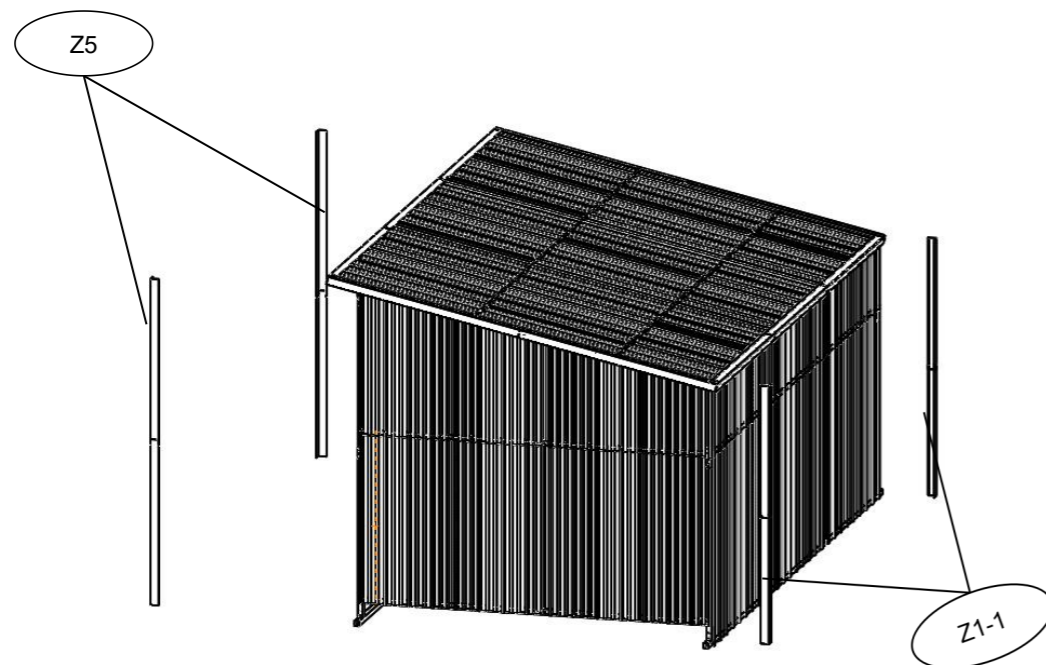

Assembly Instructions

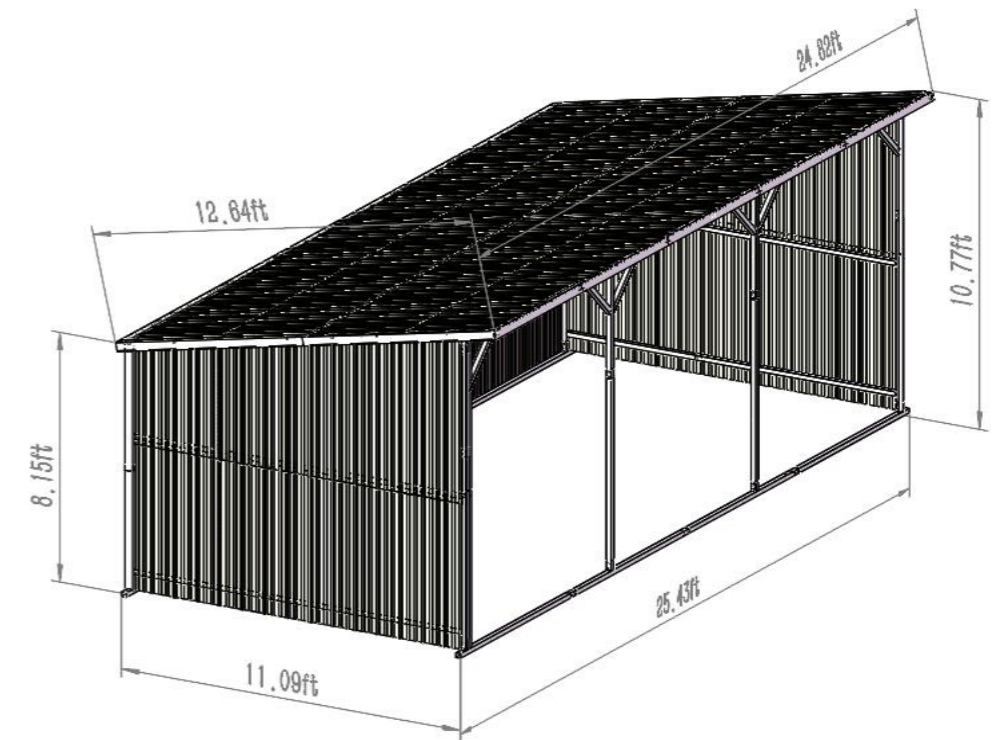

Model:2512-V3.0

Recommended Foundation: W3.38XD7.75m

CAUTION:SOME PARTS HAVE SHARP EDGES.CARE MUST BE TAKEN WHEN HANDLING THE VARIOUS PIECES TO AVOID A MISHAP.FOR SAFETY SAKE,PLEASE READ SAFETY INFORMATION PROVIDED IN THIS MANUAL BEFORE BEGINNING CONSTRUCTION.WEAR GLOVES WHEN HANDLING METAL PARTS.

BEFORE YOU START:

- Before beginning construction, check local building codes regarding footings, location and other requirements. Study and understand this owner's manual. Important information and helpful tips will make your construction easier and more enjoyable.
 - Instructions are supplied in this manual and contain all appropriate information for your building model. Review all instructions before you begin, and during assembly, follow the step sequence carefully for successful results.
- Identify all parts and check quantities against parts list.
- Be sure the day you select to install your building is dry and calm. Do not attempt to assemble your building on a windy day. Be careful on wet or muddy ground.
 - Whenever possible, two or more people should work together to assemble your building. One person can position parts or panels while the other is able to handle the fasteners and the tools.

SAFETY FIRST!





























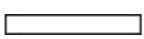

Safety precautions are important to follow throughout the construction of your building

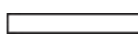
- Care must be taken when handling various pieces of your building since some contain sharp edges. Please wear work gloves, eye protection and long sleeves when assembling or performing any maintenance on your building.
- Never concentrate your total weight on the roof of the building. When using a step ladder make sure that it is fully open and on even ground before climbing on it.
- Practice caution with the tools being used in the assembly of this building. Be familiar with the operation of all power tools.
- Do not attempt to assemble the building if parts are missing because any building left partially assembled may be seriously damaged by light winds.
- Do not attempt to assemble the building on a windy day, because the large panels acting as a "sail" can be whipped about by the wind; making construction difficult and unsafe.

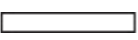

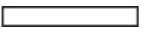







WARRANTY REQUIREMENTS:

- Wash all surfaces annually using a hose and soft nylon brush.
- Within 2 km of coast -wash every 3 months as above. After a storm, wash the cladding and the gutters as soon as possible to remove any highly corrosive salt deposits.
- Volcanic Ash Fallout -wash as soon as possible, removing fall out from roof and gutters.
- Do not allow manures, chemicals or other corrosive materials to have direct contact with cladding.

PARTS LIST

Item no.	Reference Image	Qty.	Item no.	Reference Image	Qty.
A1		4	P1		14
A2		1	P1-1		1
A3		1	P1-2		8
A4		2	P1-3		1
A5		2	P1-4		2
A6		2	P1-5		1
A7		9	P1-6		1
A8		4	P1-7		1
A9		6	P1-8		1
A10		5	P1-9		1
A11		5	P1-10		1
A12		4	P1-11		1
A13		4	P1-12		1
A14		4	P2		16
B1		20	P2-1		2

PARTS LIST

Item no.	Reference Image	Qty.
Z1		12
Z1-1		4
Z2		4
Z5		4
L2		24
L3		40
L6		12
S1		364
S1-1		508
S2		68
S4		10

FRAME

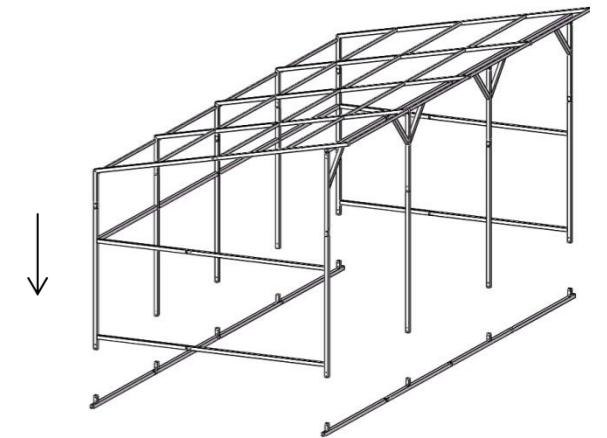
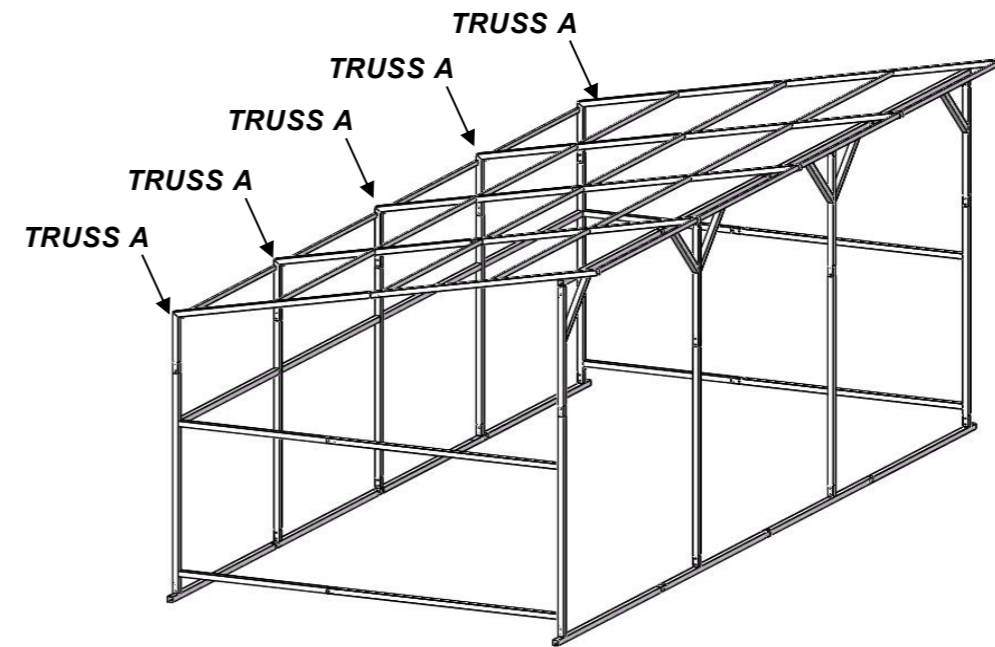

Tip

General connection method for square tubes.

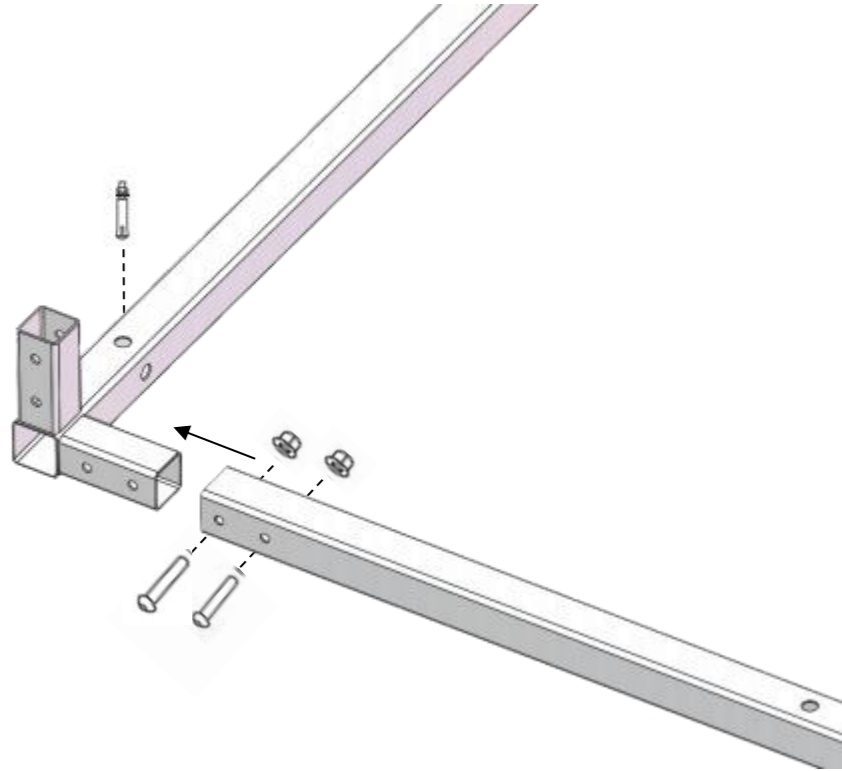

If you encounter difficulty inserting the connecting tube, please use a file to remove the burrs on the head of the square tube

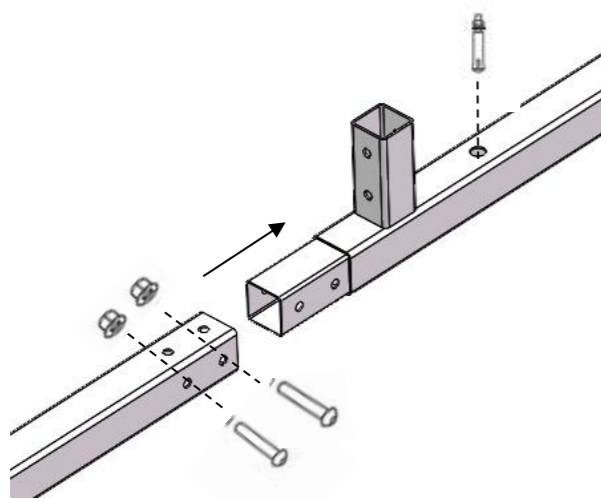

Step 1

A1x4 A2x1 A3x1 A4X1 A5X1 S2x8 S4x10

1. Refer to the foundation structure Figure, draw lines on the ground for positioning, all dimension lines are drawn from the center of the pipe to the center.
2. Fixed on the ground with (S4) expansion bolts.
3. Check the dimensions to ensure that the installation direction and position of each component are correct.

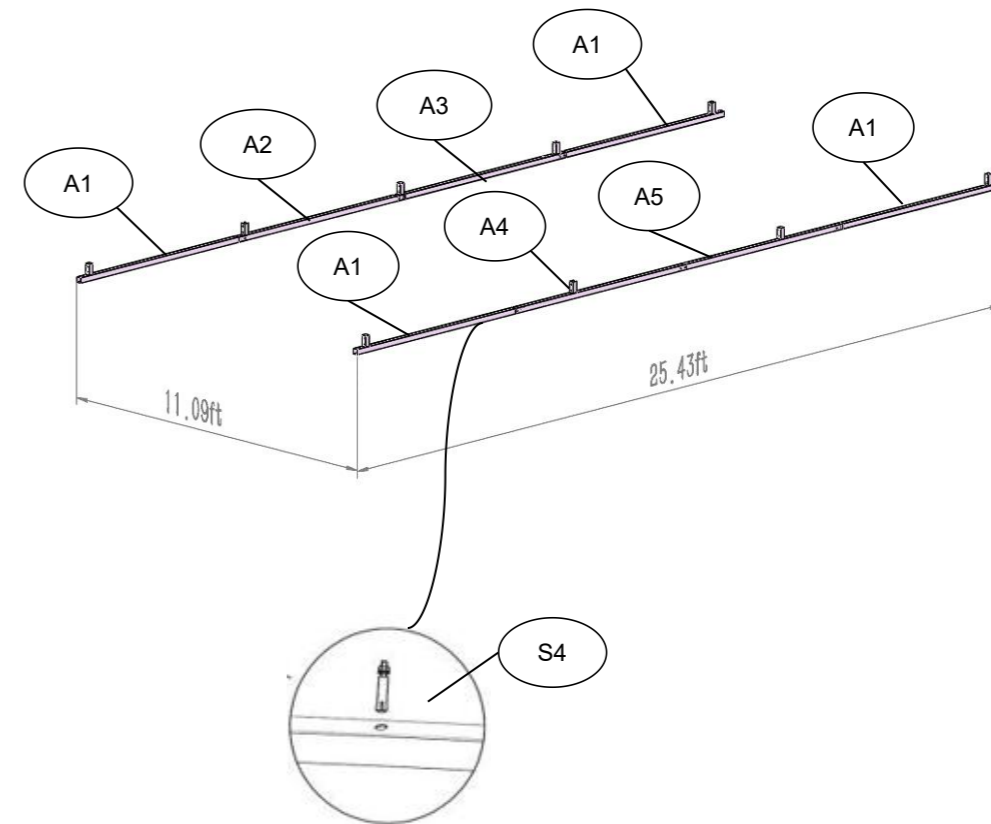

Step 2

A4x1 A5x1 A6x2 A7X4 A8X4 A9X6 L6X12 S1x60 S2x22

Flush with the outside

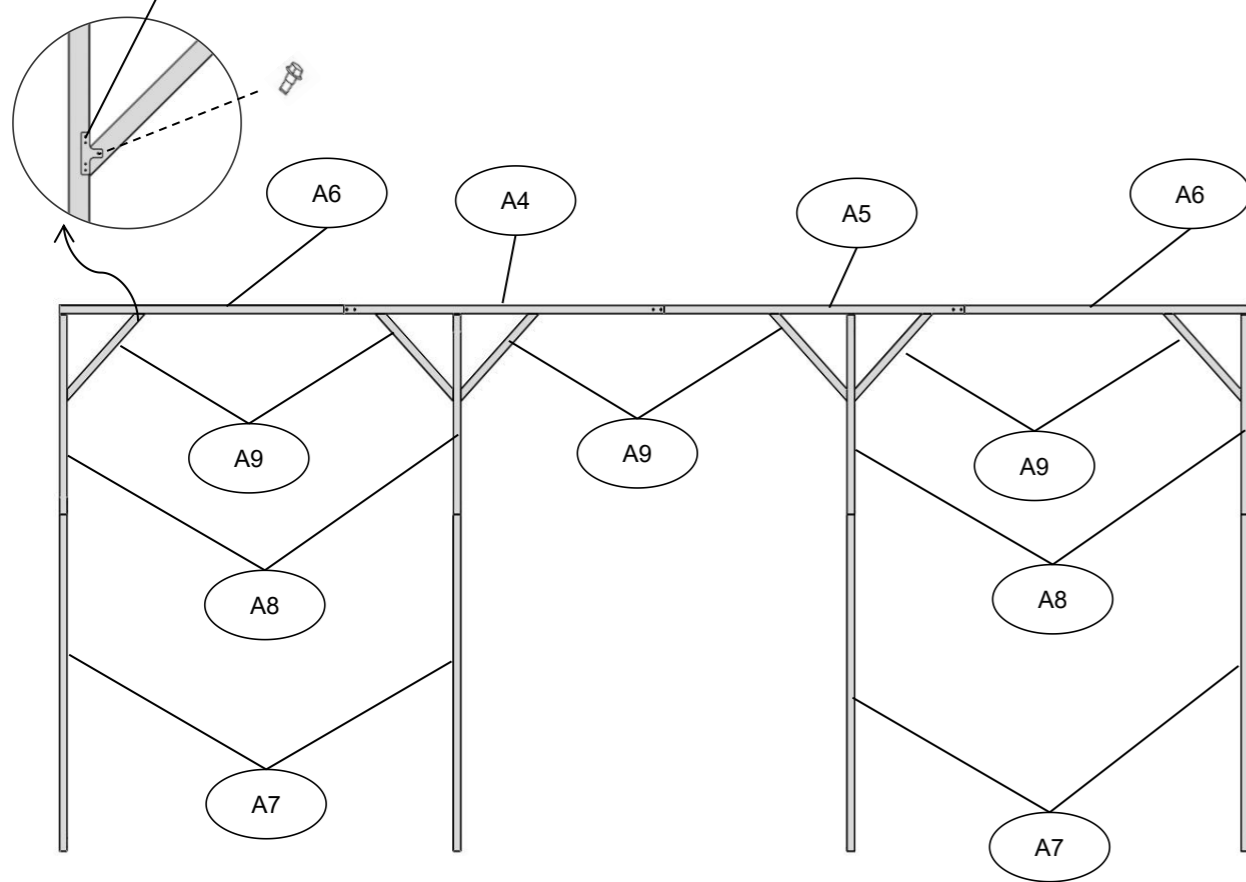

Step 3

A7X5 A10X5 A11X5 S2x20

TRUSS A x5

Pay attention to the direction of A10

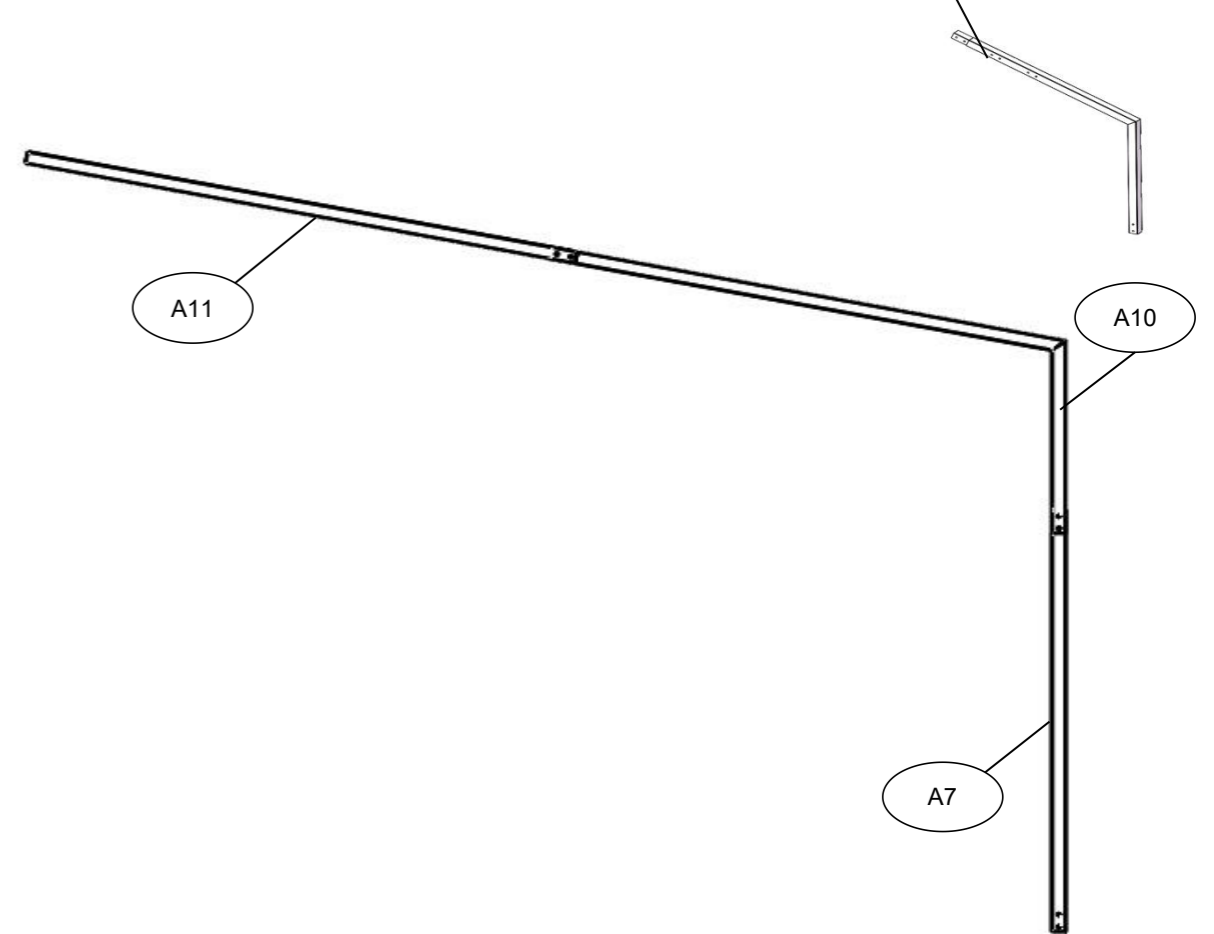

Step 4

L2X8 S1X48 S2x18

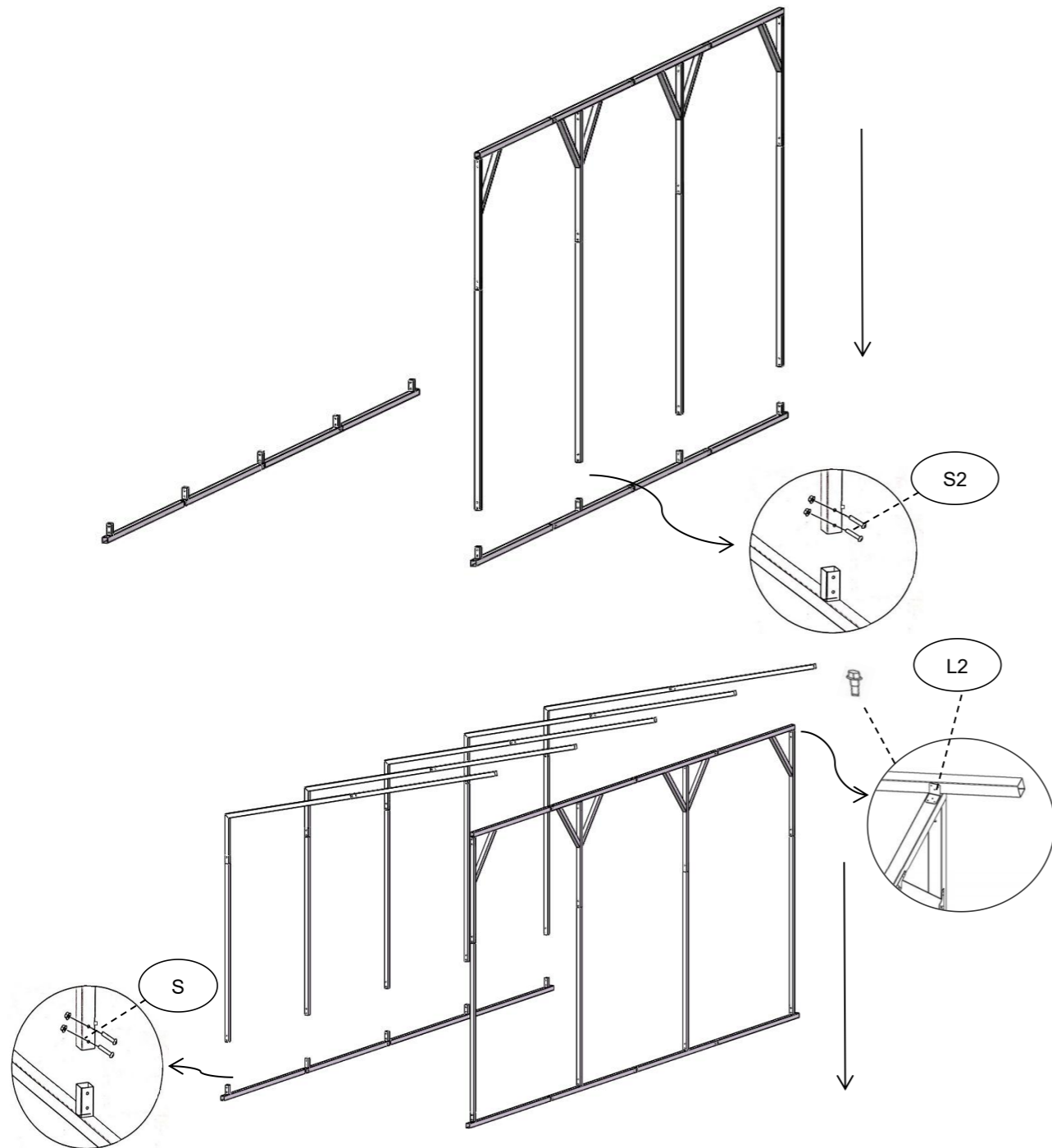

Step 5

A12X4 A13X4 A14X4 L2X16 S1X96 S2X8

Flush with the outside

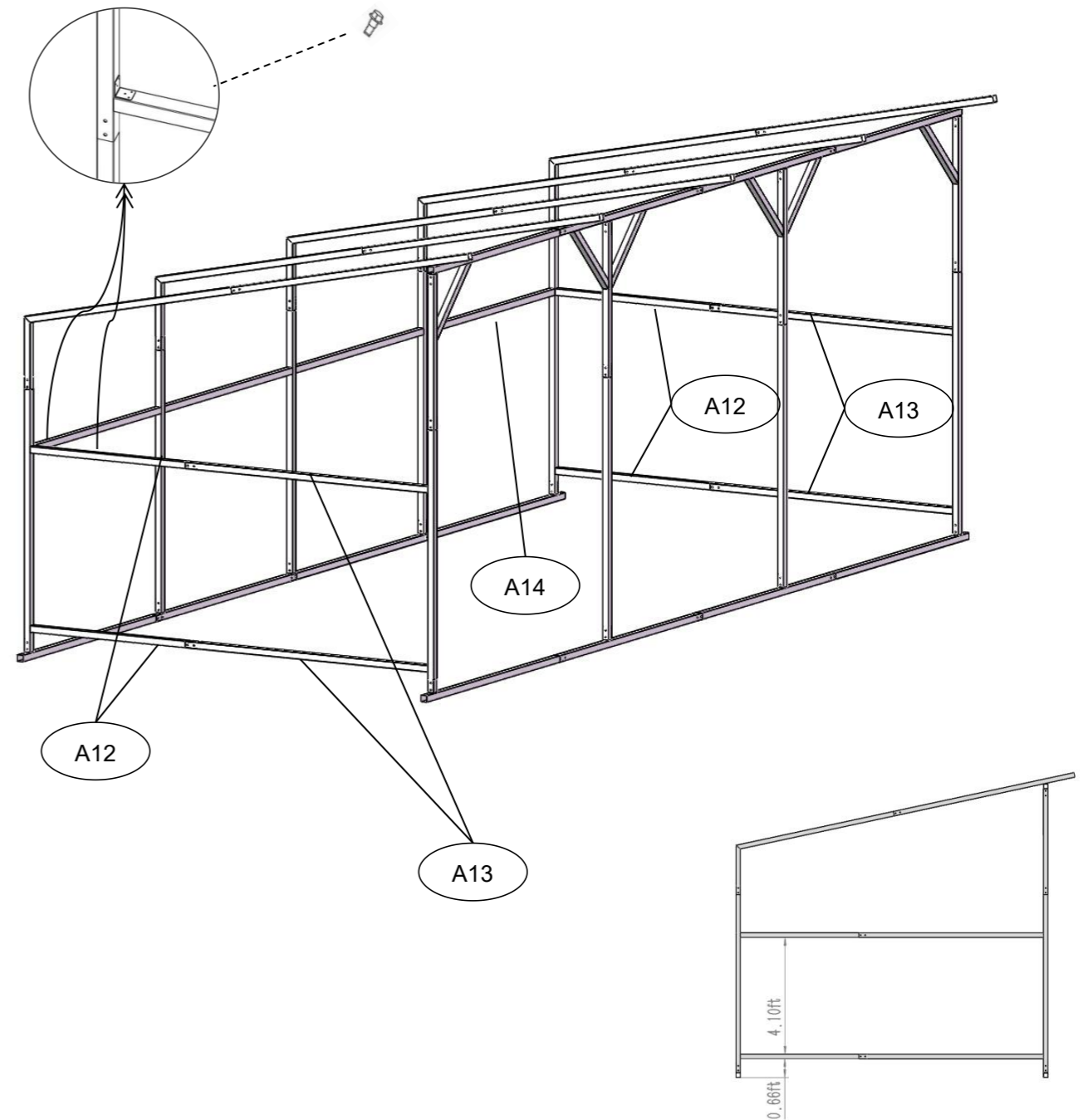

Step 6

B1x20 L3x40 S1x160

Flush with th outside

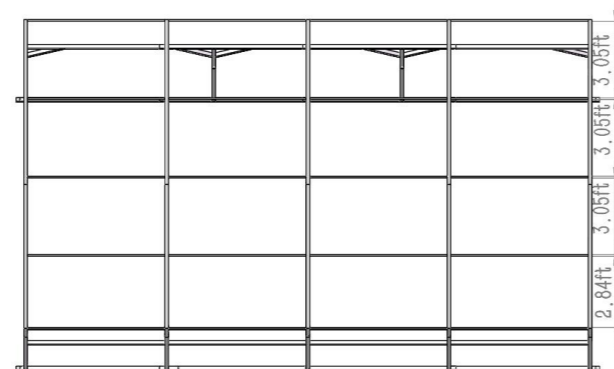
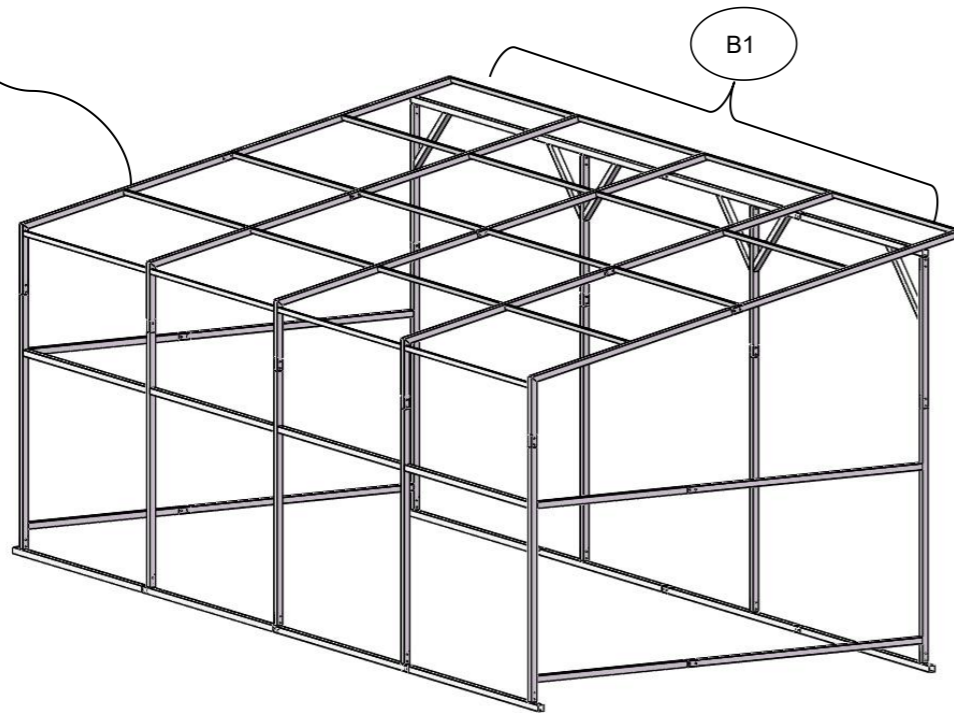
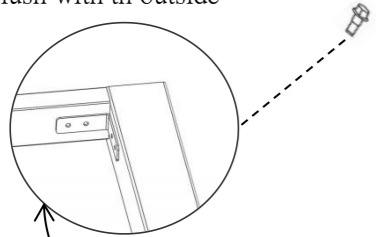

Step 7

P1X8 P1-1X1 P1-2X8 P1-3X1 S1-1X84

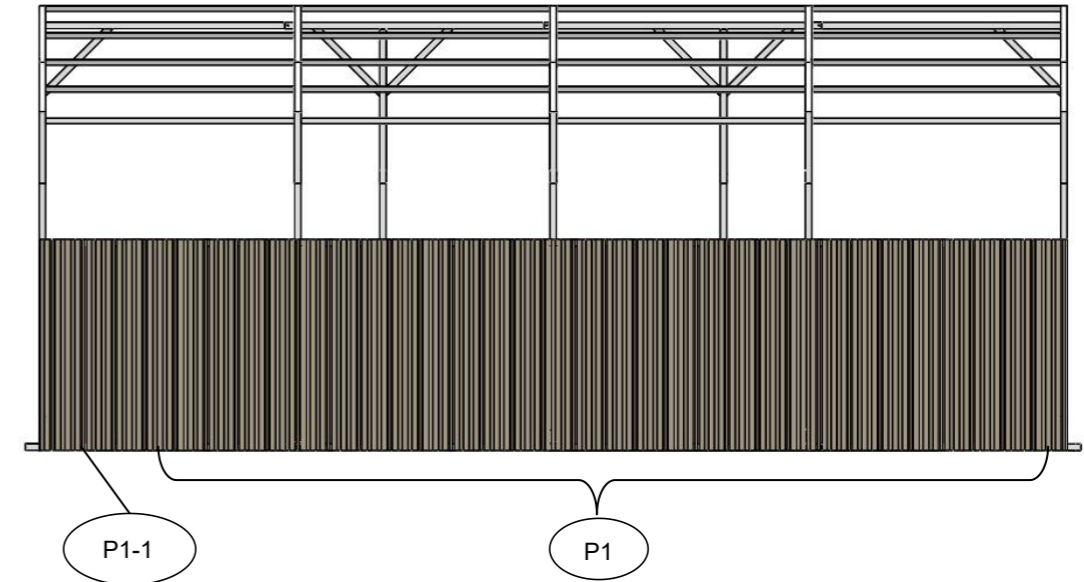

⚠ When two panels overlap, make sure upper panel covers the lower panel.

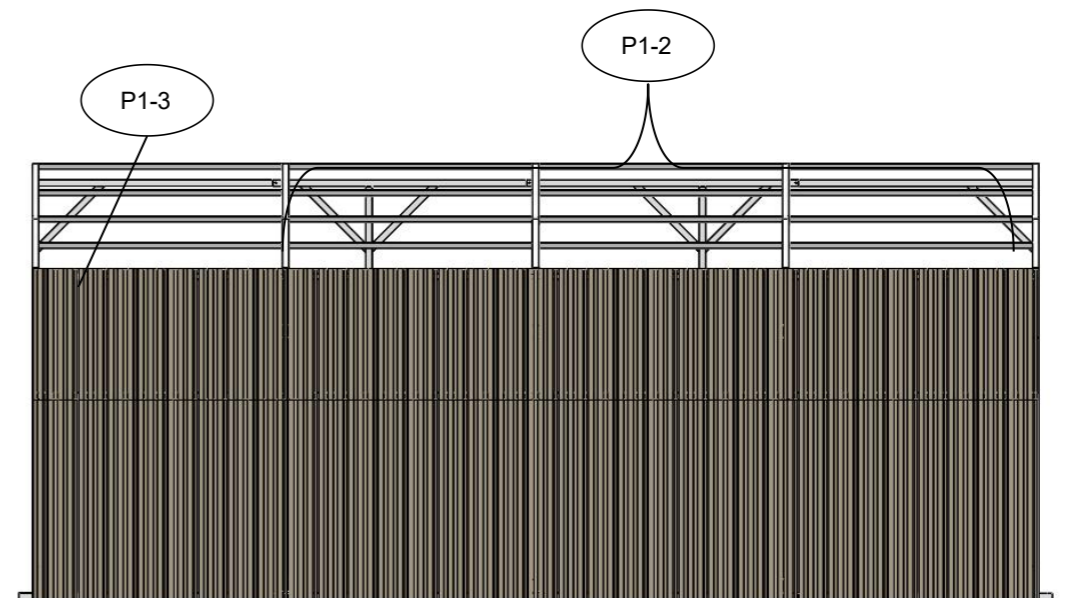

Step 8

P1X3 P1-4X1 P1-5X1 P1-6X1 P1-7X1 P1-8X1 S1-1X50

⚠ When two panels overlap, make sure upper panel covers the lower panel.

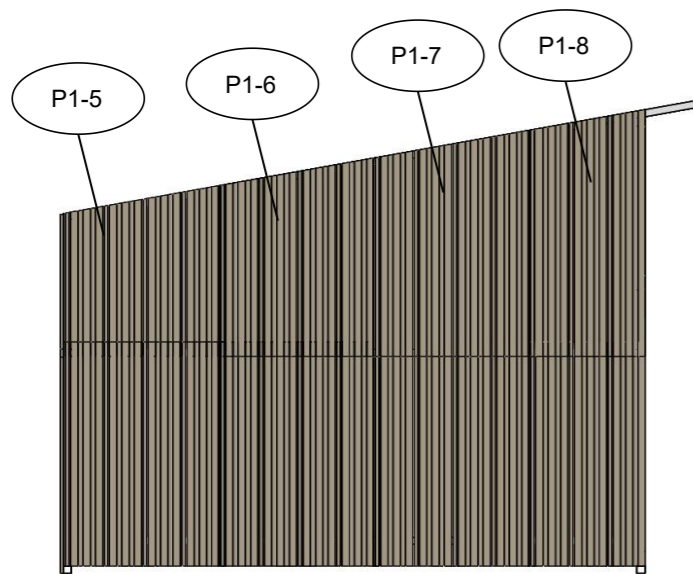
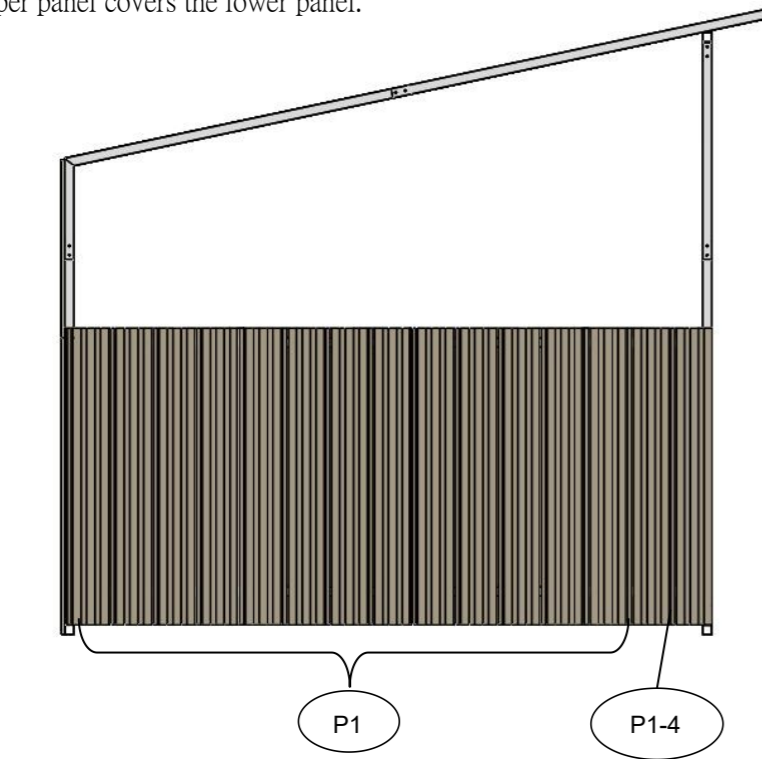

Step 9

P1X3 P1-4X1 P1-9X1 P1-10X1 P1-11X1 P1-12X1 S1-1X50

⚠ When two panels overlap, make sure upper panel covers the lower panel.

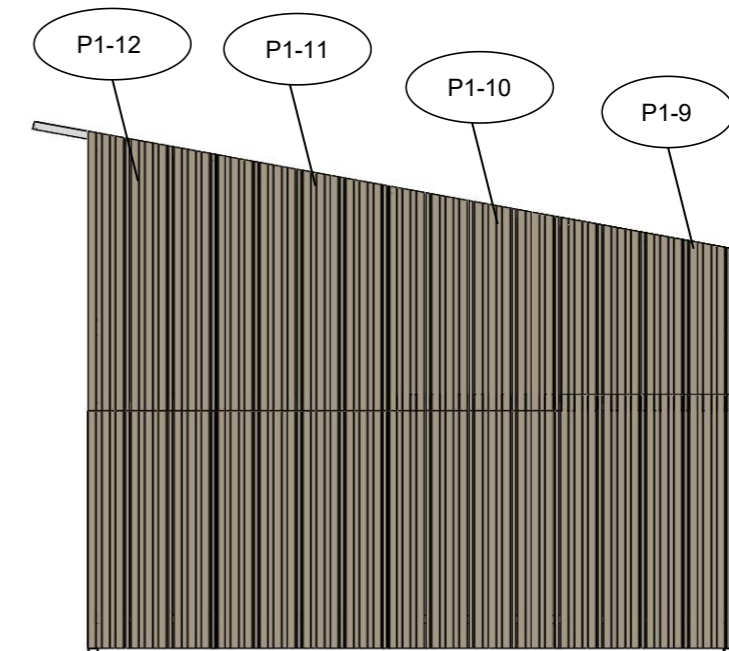
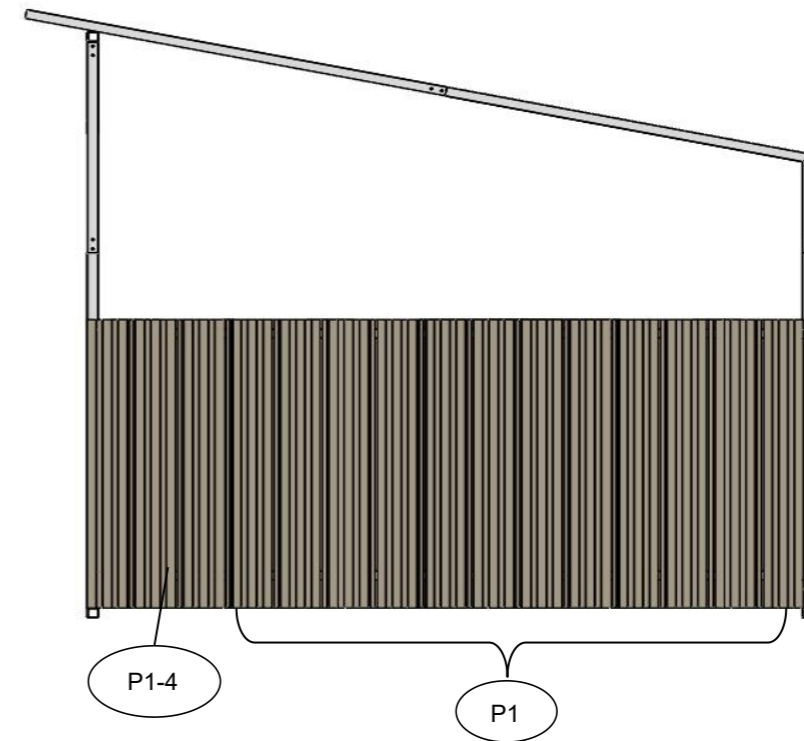

Step 10

P2x16 P2-1x2 Z2X4 S1-1x144

! When two panels overlap, make sure upper panel covers the lower panel.

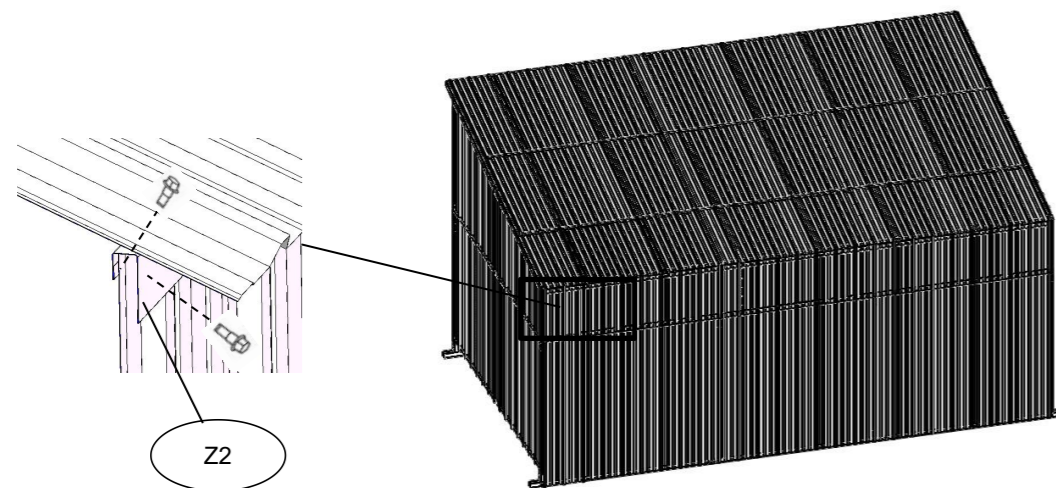
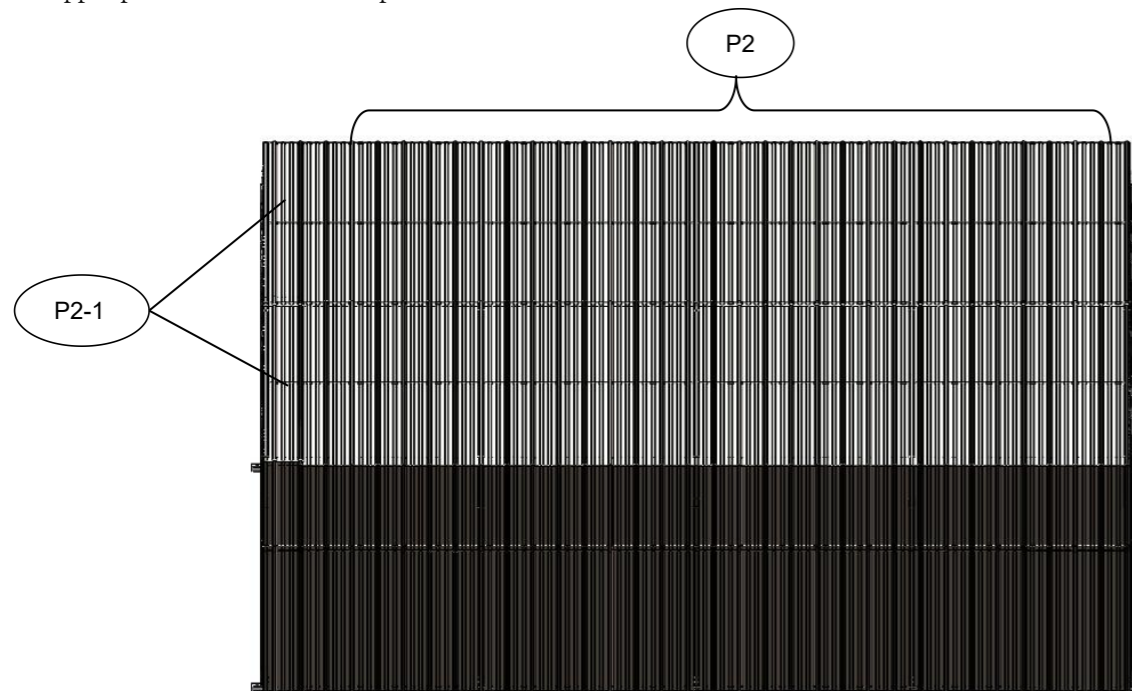

Step 11

Z1x12 S1-1x100

! When two panels overlap, make sure upper panel covers the lower panel.

